

Embedded Systems SIA, VAT No LV40003411103
47. Katolu str., Riga, LV 1003, LATVIA
Phone: +371 67648888, fax: +371 67205036, e-mail: sales@openrb.com

CANx 6 x 0-10V Analog outputs

ENG - Data sheet

Issue date 10.04.2019

Application

6 channel CAN analog outputs extension is designed to be used in building and industrial automation applications as an extension module to LogicMachine series devices based on CAN FT bus and LoRa 433 wireless. The configuration and monitoring of the device is done through separate LogicMachine CANx application. The device is designed for DIN-rail mounting and requires 3 DIN-units.

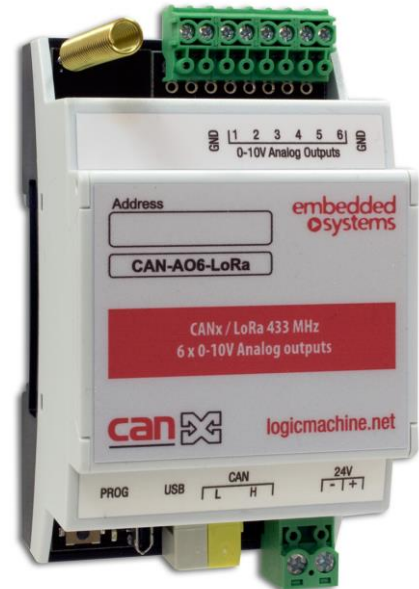

Types of product	
CAN-AO6	CANx 6 x 0-10V Analog outputs
CAN-AO6-LoRa	CANx / LoRa 433 MHz 6 x 0-10V Analog outputs
Technical data	
Power supply	12-32V DC
Power consumption (at 24V)	16 mA (outputs activated), 0.2 mA (max current per channel)
DC overvoltage protection:	50 V
Wrong wiring polarity protection	Yes
Interfaces and operating elements	
0-10V outputs	6
USB	1 microUSB for upgrade firmware flashing
CAN FT	1
LED	1 – CPU load, 1 - Error, 2 – RX/TX LoRa
Programming/reset button	1
LoRa specification	
Power on transmitter	1.6-50 mW (software adjustable)
Frequency range	433-434,750 MHz
Channel bandwidth	125 / 250 / 500 kHz
Carrier frequency step	125 kHz
Spreading factor	7-12
Clamps and enclosure	
CAN FT Terminal	0.8mm ²
Outputs	3.5 mm ²
Power supply	5 mm ²
Color	Gray
Dimensions	52(W)x100(H)x68(L) mm
Protection	IP20 according to EN 60529
Usage temperature	-5C ... +55C
Storage temperature	-20C ... +70C
Net weight:	86 g
Gross weight	97 g
Standards and norms compliance	
CE conformity	EMBS-CE-190223/04 Electromagnetic compatibility
EMC	EN61000-6-1, EN61000-6-3



Caution

Security advice

The installation and assembly of electrical equipment may only be performed by skilled electrician. The devices must not be used in any relation with equipment that supports, directly or indirectly, human health or life or with application that can result danger of people, animals or real value

Mounting advice

The devices are supplied in operational status. The cables connections included can be clamped to the housing if required.

Electrical connection

The devices are constructed for the operation of protective low voltage (SELV). Grounding of device not needed. When switching the power supply on or off, power surges must be avoided.

Default settings

Line ID: 0

Node ID: 1

Max. number of group addresses per object : 16

Reset to defaults

Press programming button for 5 seconds, the RED LED blinks 2 times, then release button - GREEN lights up shortly.

Programming physical address

Press *Tools* → *Write device address* from CANx app. Choose address and press *Write*. Then press programming button shortly on the device, GREEN LED lights up shortly. The LED is switched off automatically in 1 second which means address is written.

Connection diagram

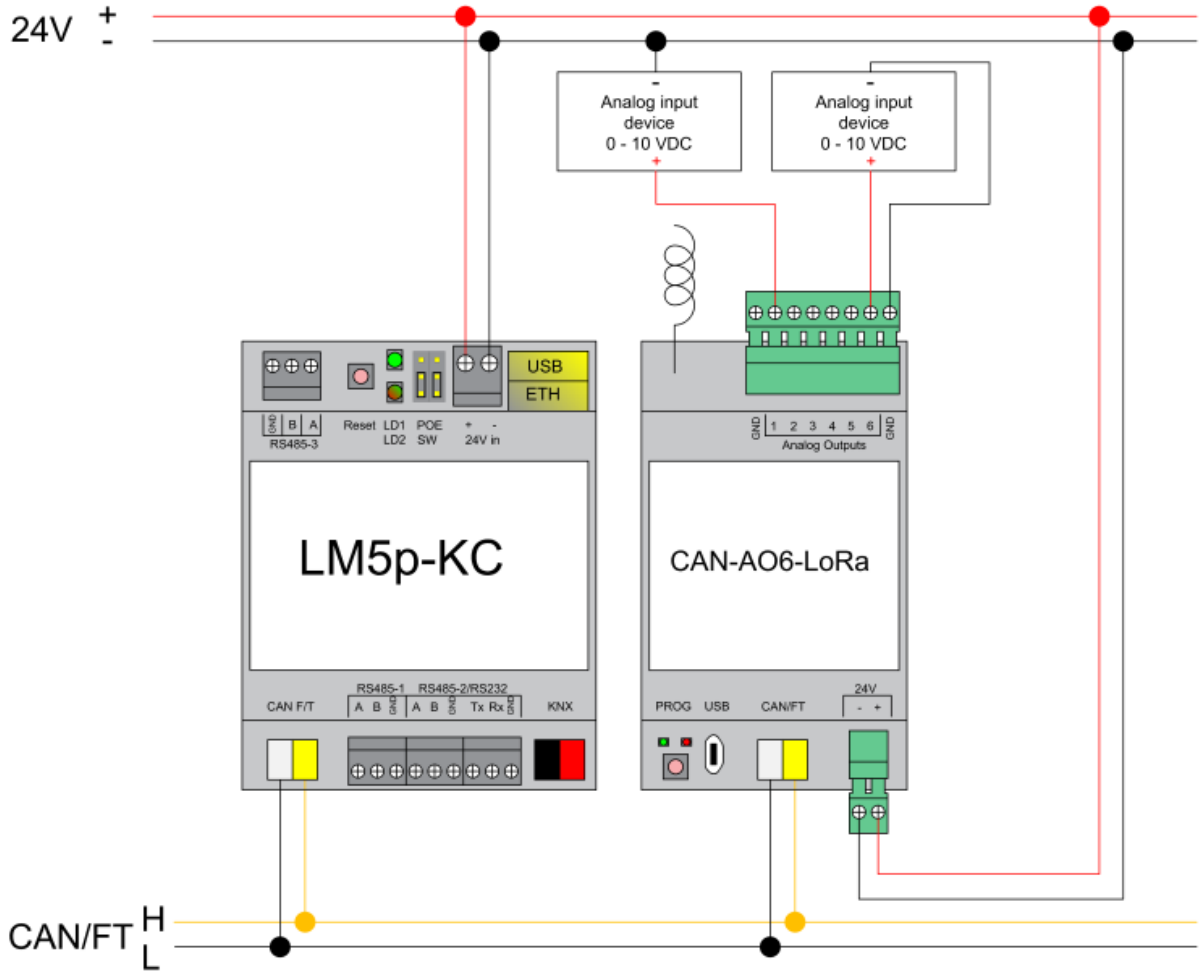

CANx software settings

Direct control

On/Off – on or off object (10..100%; use last value). Default flags: transmit (T), write (W)

AO6 (6 0-10V outputs + LoRa) (0.1) Device location + Add - No location - x

All Enabled Disabled On/Off Brightness On/Off status Brightness status

- Port 1 - direct control**
- Port 1 - start/stop dimming
- Port 2 - direct control
- Port 2 - start/stop dimming
- Port 3 - direct control
- Port 3 - start/stop dimming
- Port 4 - direct control
- Port 4 - start/stop dimming
- Port 5 - direct control

On/Off

On preset: use last value v

- Disabled
- On preset: 10%
- On preset: 20%
- On preset: 30%**
- On preset: 40%
- On preset: 50%
- On preset: 60%
- On preset: 70%
- On preset: 80%
- On preset: 90%
- On preset: 100%
- On preset: use last value

Flags

F T R W

Brightness – specify brightness object and transition time (1..10 seconds; no transition). Default flags: transmit (T), write (W)

AO6 (6 0-10V outputs + LoRa) (0.1) Device location + Add - No location - x

All Enabled Disabled On/Off Brightness On/Off status Brightness status

- Port 1 - direct control**
- Port 1 - start/stop dimming
- Port 2 - direct control
- Port 2 - start/stop dimming
- Port 3 - direct control
- Port 3 - start/stop dimming
- Port 4 - direct control
- Port 4 - start/stop dimming
- Port 5 - direct control

Brightness

Transition: 1 second v

- Disabled
- No transition
- Transition: 1 second**
- Transition: 2 second
- Transition: 3 second
- Transition: 4 second
- Transition: 5 second
- Transition: 6 second
- Transition: 7 second
- Transition: 8 second
- Transition: 9 second
- Transition: 10 seconds

Flags

F T R W

On/Off status – define either On/Off status object is enabled and specify group addresses. Default flags: transmit (T), read (R)

AO6 (6 0-10V outputs + LoRa) (0.1) Device location + Add - No location - v x

All Enabled Disabled On/Off ✔ Brightness ✔ On/Off status ✔ Brightness status ✔

Port 1 - direct control Port 1 - start/stop dimming Port 2 - direct control Port 2 - start/stop dimming Port 3 - direct control Port 3 - start/stop dimming Port 4 - direct control

On/Off status **Flags**

v F T R W

Group addresses + Add 1 bit (boolean)

Q No group addresses selected

Tags

Q No tags set

Brightness status – define either Brightness status object is enabled and specify group addresses. Default flags: transmit (T), read (R)

AO6 (6 0-10V outputs + LoRa) (0.1) Device location + Add - No location - v x

All Enabled Disabled On/Off ✔ Brightness ✔ On/Off status ✔ Brightness status ✔

Port 1 - direct control Port 1 - start/stop dimming Port 2 - direct control Port 2 - start/stop dimming Port 3 - direct control Port 3 - start/stop dimming Port 4 - direct control

Brightness status **Flags**

Enabled v F T R W

Group addresses + Add 1 byte unsigned integer

Q No group addresses selected

Tags

Q No tags set

Start/stop dimming

Dim up/down – 1bit dimming with specified transition time. If current value is 0, it will dim up. If current value is larger than 0, it will alternate between up/down dimming. Default flags: transmit (T), write (W)

AO6 (6 0-10V outputs + LoRa) (0.1) Device location + Add - No location - x

All Enabled Disabled

- Port 1 - direct control
- Port 1 - dimming
- Port 2 - direct control
- Port 2 - dimming
- Port 3 - direct control
- Port 3 - dimming
- Port 4 - direct control

Dim up/down ✔ Dim up ✔ Dim down ✔ Dim 4 bit ✔

Dim up/down

Transition: 5 second v

Flags

FTRW

Group addresses + Add 1 bit (boolean)

Q No group addresses selected

Tags

Q No tags set

Dim up – 1bit dimming Up object with specified transition time. Default flags: transmit (T), write (W)

AO6 (6 0-10V outputs + LoRa) (0.1) Device location + Add - No location - x

All Enabled Disabled

- Port 1 - direct control
- Port 1 - dimming
- Port 2 - direct control
- Port 2 - dimming
- Port 3 - direct control
- Port 3 - dimming
- Port 4 - direct control

Dim up/down ✔ Dim up ✔ Dim down ✔ Dim 4 bit ✔

Dim up

Transition: 5 second v

Flags

FTRW

Group addresses + Add 1 bit (boolean)

Q No group addresses selected

Tags

Q No tags set

Dim down – 1bit dimming Down object with specified transition time. Default flags: transmit (T), write (W)

AO6 (6 0-10V outputs + LoRa) (0.1) Device location + Add - No location - x

All Enabled Disabled Dim up/down Dim up Dim down Dim 4 bit

Port 1 - direct control
Port 1 - dimming
Port 2 - direct control
Port 2 - dimming
Port 3 - direct control
Port 3 - dimming
Port 4 - direct control

Dim down **Flags**

Transition: 5 second F T R W

Group addresses + Add 1 bit (boolean)

Tags

Dim 4 bit – define either 4 bit dimming is enabled and specify the dimming object. Default flags: transmit (T), write (W)

AO6 (6 0-10V outputs + LoRa) (0.1) Device location + Add - No location - x

All Enabled Disabled Dim up/down Dim up Dim down Dim 4 bit

Port 1 - direct control
Port 1 - dimming
Port 2 - direct control
Port 2 - dimming
Port 3 - direct control
Port 3 - dimming
Port 4 - direct control

Dim 4 bit **Flags**

Enabled F T R W

Group addresses + Add 4 bit (dimming)

Tags

LoRa General settings

Frequency – define the frequency LoRa will operate in. Frequency should be equal on transmitter and receiver(-s).

Frequency TX power Bandwidth Spreading Factor

Frequency

433 MHz
LoRa disabled
433 MHz
433.125 MHz
433.250 MHz
433.375 MHz
433.500 MHz
433.625 MHz
433.750 MHz
433.875 MHz
434 MHz
434.125 MHz
434.250 MHz
434.375 MHz
434.500 MHz
434.625 MHz
434.750 MHz

TX power – output power of LoRa transceiver

Frequency TX power Bandwidth Spreading Factor

TX power

17 dBm
17 dBm
16 dBm
15 dBm
14 dBm
13 dBm
12 dBm
11 dBm
10 dBm
9 dBm
8 dBm
7 dBm
6 dBm
5 dBm
4 dBm
3 dBm
2 dBm

Bandwidth – define the bandwidth of the channel. The lower the bandwidth – the lower the data rate / longer the distance. Bandwidth should be equal on transmitter and receiver(-s).

Frequency TX power Bandwidth Spreading Factor

Bandwidth

- 125 kHz (lower data rate, longer range)
- 125 kHz (lower data rate, longer range)
- 250 kHz
- 500 kHz (higher data rate, shorter range)

Spreading factor - The basic principle of spread spectrum is that each bit of information is encoded as multiple chirps. Within the given bandwidth the relationship between the bit and chirp rate for LoRa modulation may differ between spreading factor (SF) 7 to 12. Spreading factor should be equal on transmitter and receiver(-s).

Frequency TX power Bandwidth Spreading Factor

Spreading Factor

- SF7 (higher data rate, shorter range)
- SF7 (higher data rate, shorter range)
- SF8
- SF9
- SF10
- SF11
- SF12 (lower data rate, longer range)

Date rates

Best case: SF7 / 500 kHz = 16ms per message (22 kbps)

Default: SF7 / 125 kHz = 62ms per message (5.5kbps)

Worst case: SF12 / 125 kHz = 1300ms per message (0.3 kbps)

2x increase in bandwidth provides 2x less air time

SF+1 takes approximately 2x more air time compared to previous SF

LoRa Messages

ACK mode – message acknowledgement mode

ACK disabled - no ACK will be done (faster and less reliable communication)

ACK enabled - each message will be acknowledged (slower, more reliable)

ACK gateway mode – the node will retransmit ACK to the next node

ACK mode | Filter mode | Statistics 

ACK mode

ACK disabled (faster, less reliable) ▼
ACK disabled (faster, less reliable)
 ACK enabled (slower, more reliable)
 ACK gateway mode (slower, more reliable)

Filter mode – define either to pass messages with F (Filter) flag enabled in object settings

Flags

F T R W

ACK mode | Filter mode | Statistics 

Filter mode

No filtering ▼
No filtering
 Pass messages without filter flag
 Pass messages with filter flag

Statistics – receive statistic information to group address – source address / RSSI signal level / TX power. Statistics telegram can be sent on all valid telegrams which are received by LoRa.

ACK mode | Filter mode | Statistics 

Statistics

Enabled (Source, RSSI, TX power) ▼

Flags

F T R W

Group addresses  Add 4 byte LoRa status

✕ 0/0/3 R6 (6 Relay outputs + LoRa) - Statistics
 Q

Tags

Q No tags set

Groups Devices Locations Connection helper Line scan Device scan Reports Monitor Tools

Name or address Datatype Tags All tags Any tag Location Exact Incl. sub Properties

Address	Name	Datatype	Tags	Value	Properties
0/0/1	UIO8 (8 Universal IO ports + LoRa) - Statistics	4.5. 4 byte LoRa status		0.4 / -15 dB / 17 dBm	E R P
0/0/2	UIO8 (8 Universal IO ports + LoRa) - Input 1	0.1. 1 bit (boolean)		0	E R P
0/0/3	R6 (6 Relay outputs + LoRa) - Statistics	4.5. 4 byte LoRa status		0.2 / -15 dB / 17 dBm	E R P

LoRa Security

Define security key 1 or/and key 2 in HEX form. Up to 8 HEX characters are supported for each of the keys. Encryption keys must be equal for all LoRa devices on the same line



Encryption key 1 Encryption key 2

38 54 3A B8 0D FD 9B CF

Up to 8 HEX characters, separated by space.
Encryption keys must be equal for all LoRa devices on the same line

Notification LEDs

- During transmission you can see two LEDs on LoRa device

	Sending LoRa telegram
	Receiving LoRa telegram

- In case statistics is enabled on receiver device and CAN FT line is disconnected from it, both LEDs will light up (receiving telegram from sender, sending telegram with statistics).
- In case ACK is enabled, both orange and blue LEDs will light up.